

Rev #		
Rev #		

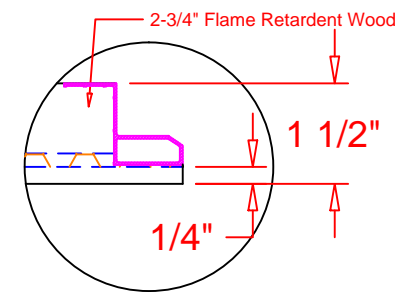
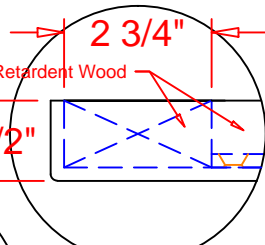
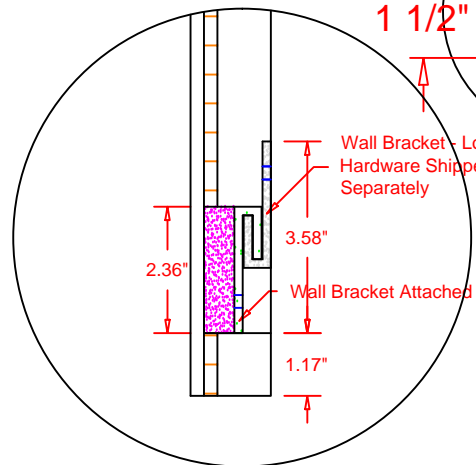
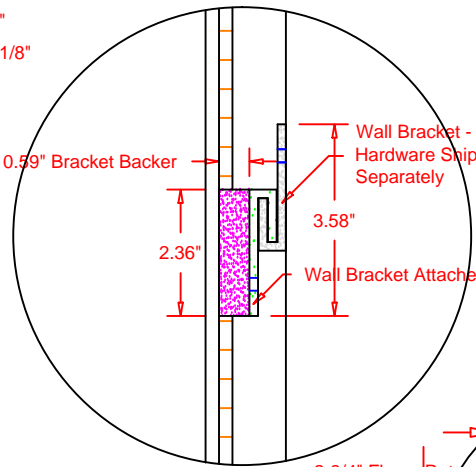
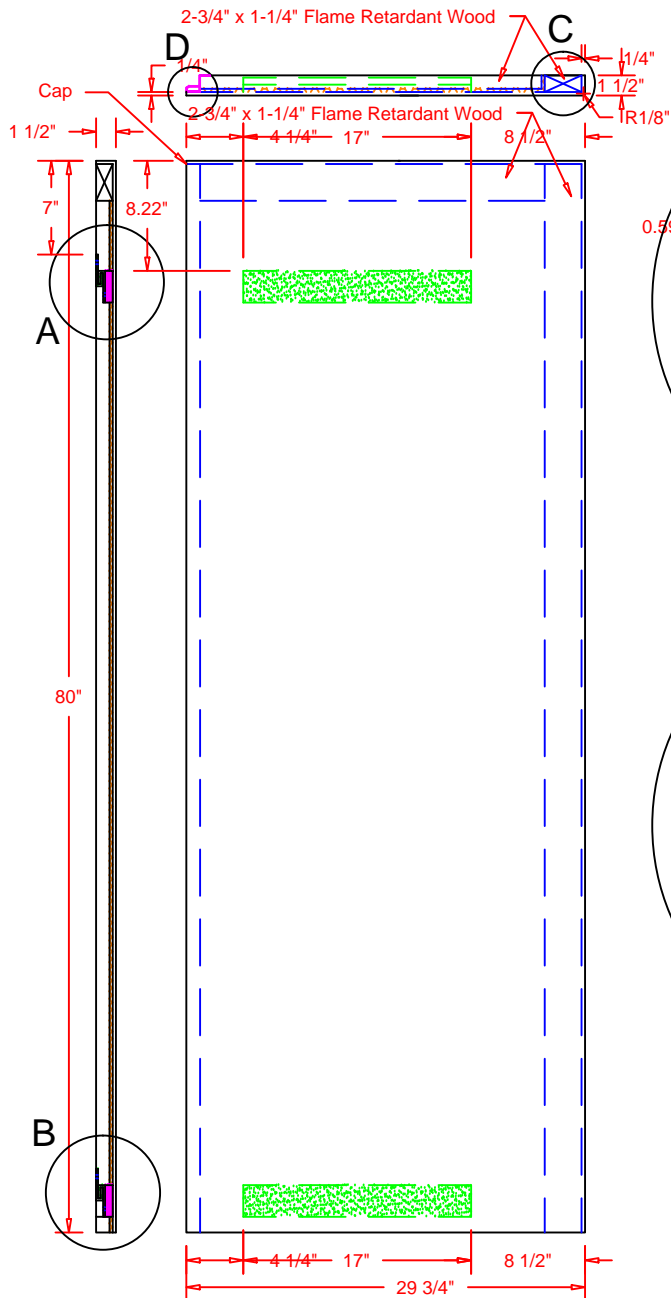

 400 Dietz Road
 Warren, OH 44482
 330-393-6624
 FAX 330-399-4426
 www.transolid.com

Part Number:	DE308R		
Description:	30" x 60" - Right Wall		
Date Drawn:	12/05/13	Weight:	None
		Scale:	None
Drawn By:	Daniel Hollifield		Revised By:
Approved By:		Date Revised:	

Customer Approval: _____ Date: _____

Path: @Engineering\2 Commercial